

GLAZINGVISION

Installation Manual

Free Standing Skybox

Installation is to be undertaken ONLY by Glazing Vision Engineers or Approved Installers.

The product MUST then be commissioned by Glazing Vision Engineers or Approved Installers.

Contents

Section Description	Page
Introduction	3
Safety Information	4
Pre-Installation Preparation	6
Upstand Top Trim Installation	8
Fitting the Lifting Equipment	9
Installation Procedure	10
Interior Finishing	13
Commissioning	14

Introduction

Thank you for purchasing a Glazing Vision Free Standing Skybox. In order to ensure that it gives you many years of service it is important that before commencing any work you read these instructions fully and ensure that they are strictly followed for a successful and trouble free installation.

We recommend that the installation should be undertaken by Glazing Vision Engineers or Approved Installers (installers that have attended a Glazing Vision Installation training course for this product and carry 'Approved Installer' status). This will ensure a reliable product and enable the property owner to benefit from the full 10 year warranty on the product. It should be noted that an installation by non-approved installers will result in a reduced warranty period of just 2 years.

By following the correct installation procedure, a reliable and high performing end result is guaranteed. The critical operations that can lead to problems if not done correctly are the lifting, preparation of the upstand, and ensuring the correct line and level when mounting. Taking the time to carry out these operations correctly will ensure that the product does not twist or distort and allow the installed product to move freely and unimpeded with minimum load on the mechanisms and no undue stresses in the frame or glass.







Care should be taken when working on the product, avoiding accidental damage and ensuring operational reliability.

Should you have any queries beyond this manual please do not hesitate to contact Glazing Vision.



Safety Information

Installation of your rooflight may involve working at heights, working at an unusual angle, being in unfamiliar locations or all of these. **Before** work is commenced, stop and consider the best way to carry out the task and what hazards you might encounter.

	<p>Let our experts carry out your routine maintenance with a maintenance contract.</p> <p>☎ +44 (0)1379 658300</p> <p>✉ info@glazingvision.co.uk</p>
	<p>These products can be very heavy. Extreme care must be taken during handling and installation. Full consideration should be given to how you will safely transport your rooflight product from the delivery vehicle to the installation location. Glazing Vision strongly recommends that specialist, mechanical lifting equipment is employed.</p>
	<p>Consider:</p> <ul style="list-style-type: none"> • The weight(s) of the product purchased. • How you will safely transport your rooflight product from the delivery vehicle to the installation location. • All lifting methods and equipment required for safe installation to eliminate manual handling. • How you will safely access the area to carry out installation. • Any openings, voids or unprotected edges that might pose a significant risk whilst working at height. • Use of scaffolding with all appropriate edging, rails and inspection certification. • If specialist access or equipment is required e.g. a fall arrest system. • What personal protective safety equipment (PPE) is required for working at height – e.g. harness. • Methods for safe working, for example, to avoid falling from height, reducing manual handling and so as not to drop equipment. • How you will transport tools and other equipment to the installation area. • The number of persons required to assist with safe installation. • The competence, capability and experience of the installation team to safely carry out the task. • Impact of weather on safe installation, especially driving rain and high winds. <p>If in doubt, please contact Glazing Vision for assistance.</p>
	<p>Anticipated hazards may include:</p> <ul style="list-style-type: none"> • Falls from height • Working with specialist lifting equipment or third-party lifting • Manual handling injury • Equipment falling from height • Slips, trips and falls • Fragile roof areas. • Finger or clothing entrapment under unit, in mechanical or moving parts • Working with electricity • Impact of weather conditions • Competence of personnel
	<p>Do not attempt to repair, move or dismantle the product unless suitably competent and qualified to do so, with the appropriate safety measures in place. Any repairs and/or movement of the product may invalidate the warranty. Please seek advice from Glazing Vision.</p>
	<p>Any electrical work is to be carried out by a qualified and competent electrician in accordance with Glazing Vision's wiring diagram(s).</p>



Warning

The following warnings are here to prevent personal injury and damage to the product. Please follow them explicitly.

General:

- The product must be properly installed and commissioned in accordance with this manual before it is used.
- Glazing Vision strongly recommends that any work is carried out by suitably qualified individuals (e.g. Glazing Vision Engineers or Approved Installers, or an experienced electro-mechanical service engineer).
- Glazing Vision strongly recommends that specialist, mechanical lifting equipment is employed.
- Use the product only for its intended purpose.
- Regular cleaning and maintenance must be carried out according to guidelines.
- A safe working platform must be provided for any installation/maintenance work carried out. This includes suitable edge protection.
- Glazing Vision cannot be held responsible for damage incurred during the lifting and transportation of the product to the installation location (please refer to terms and conditions of sale).

Pre-Installation:

- Glazing Vision products are heavy, fragile and of awkward shape and size. There may be uneven weight distribution due to the materials used and their design.
- The weight(s) of each individual product (or product section) will be clearly marked on the product and will be communicated to clients before despatch of goods.
- Never install any product showing signs of damage. If in doubt consult Glazing Vision for advice.
- Please dispose of the packaging material for this product in a considerate manner. Cardboard and wood items are widely recycled.

Electrical Works/Cables:

- It is recommended that electrical work is carried out by a qualified and competent electrician.
- Do not pull, squash, bend or damage cables where they exit the product. Doing so may loosen connections and this may result in damage to the product and/or create the need for a repair visit.
- Should any cables or electrical components break or become damaged, have them repaired or replaced immediately. Deteriorated insulation of electrical parts or overloading may cause an electric shock or fire.
- Do not install the circuitry in a damp place or a place where it may come into contact with water.

During Use:

- Do not touch the motors/mechanisms after operating the unit as they may become hot.
- Do not walk or sit on the unit (except for the dedicated treadplate).
- Risk of crush and/or trapping injuries. Make sure that fingers and other obstructions are kept clear of the product and its mechanisms at all times. Proximity (safety) sensors are fitted as standard, however care must still be taken.
- Overcurrent protection is designed to prevent damage to the product and its mechanisms. It should not be relied upon to prevent injuries.
- Do not place anything on, or cause obstruction to, the moving sections of the product as this may cause damage to the mechanisms/product and/or prevent the unit from opening/closing.
- Do not allow unauthorised persons (e.g. children) to operate the product as this may lead to personal injury or damage to the product. Do not leave children or pets unsupervised near the product – it may open/close unexpectedly (e.g. due to the rain sensor activating) and cause injury.
- Do not leave the product open in the rain, this could damage the control board and/or mechanisms. If required, a rain sensor can be specified at the time of order.

For more information or assistance please contact Glazing Vision.

Pre-Installation Preparation



These products can be very heavy. Due consideration should be given to getting the product onto the roof safely and extreme care taken during installation.

Points to Note Prior to Commencing Installation

1. The Free Standing Skybox should arrive on site in undamaged packaging, which includes a wooden build frame, cardboard, polyfoam glass protection and low tack tape. Please inspect for damage to packaging and/or product and advise Glazing Vision of any damage or shortfall within 48 hours from signing the receipt of your delivery.
2. Enclosed within the box containing this manual will be the required number of fixing woodscrews and a number of plastic packers, as well as some silicone and other required materials. The installation kit is supplied with a control switch, a Power Supply Unit (PSU) and any additional optional items selected at the time of order.

Standard Installation Hardware

Enclosed within the hardware box for each unit you should find at least the following:

Stainless steel woodscrews



Plastic horseshoe packers

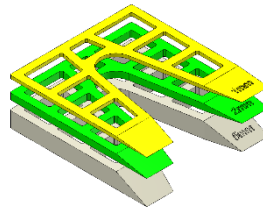

(various sizes)

Low modulus silicone



3. Free Standing Skyboxes have two coiled cables emerging from the motor housing as standard (if optional extras have been selected, other cables may also be present). This includes 2 single cores (red and black) 24V DC power cables and a 6 core control cable. These cables will have identification labels on them (labels should not be removed until final installation). Please refer to Glazing Vision's wiring diagrams for details of wiring requirements. Only the supplied PSU can be fitted to the unit, failure to connect this unit or wiring direct to the mains will invalidate the product warranty.
4. The switch used to control the operation of the Free Standing Skybox is a two button wall mounted control switch. This switch will allow you to operate and stop at any position between the fully open and closed positions. This switch also contains a tri-colour LED to display the product status to the user. The correct control switch is supplied in the installation kit and must be installed to avoid invalidating the warranty. If required, this switch can be installed in a maintenance area and another switch of a retractive single pole double throw (SPDT, 'on-off-on', latching off) type can be parallel wired for regular use. Using a SPDT switch that only latches 'on-on' can seize the control board and therefore should not be used.
5. The Free Standing Skybox also requires a 3A fused double pole single throw (DPST) type switch (not supplied). Combined with disconnecting the battery backup (if specified), installing this switch as per the wiring diagram will allow the control board to be reset in the event of a fault (for more information on faults and troubleshooting see the operation and maintenance manual).
6. The upstand must already be in place for the product. The dimensioning of the product will have taken into consideration the external dimensions of the upstand including all weathering. More information about upstand construction can be found in Glazing Vision's sales drawings. **Please note that a minimum distance of 300 mm clearance between the upstand and any surrounding structures must be left on all sides. Sufficient room for installation and maintenance must also be allowed for. Additional clearance may be required at the front of the product to allow room for access.**
7. It is important to ensure that the area of installation is suitably prepared. The area surrounding the upstand should be clear to provide safe access during the installation works. It will be necessary to work on the outside and therefore suitable provisions should be made for safe handling of the product, including all relevant personal protective equipment (PPE) and safety systems for working at heights.

8. Before starting installation, Glazing Vision advises that the physical upstand dimensions are cross-checked with those given for the order, to ensure the product will fit. The upstand will need to be within ± 10 mm of the ordered size. The top surface of the upstand should be flat without undulations greater than ± 2 mm. Check that the cable exit hole has been included in the upstand (refer to Glazing Vision's sales drawings for the location). Also check the diagonals to ensure that the upstand has been constructed square. The upstand must be weathered as per the sales drawings. **If using any metallic waterproofing material, this cannot be applied across the top surface of the upstand as this will cause a thermal bridge which can lead to internal condensation and invalidate the product warranty.**
9. These products can be very heavy. Glazing Vision strongly recommends that a structural engineer is consulted when designing the structure(s) that will support the product and the surrounding structure. **Nothing in this manual or on Glazing Vision's sales drawings constitutes a structural proposal.**
10. Glazing Vision strongly recommends that a 'dry run' (without any silicone) is completed before committing to the final installation.

Sales Drawings

Sales drawings for the Free Standing Skybox can be obtained by downloading them from Glazing Vision's website (www.glazingvision.co.uk/resources) or by contacting Glazing Vision.

Upstand Top Trim Installation (If Specified)

Begin by cutting the upstand top trim to the lengths required for all sides of the upstand. The corner joints can either be mitred (45°) or straight cut with notches (see image below). If the material requires bending to suit the pitch of the upstand, this can be achieved by screwing the section to the upstand as below and gently tapping the horizontal part using a clean rubber mallet.

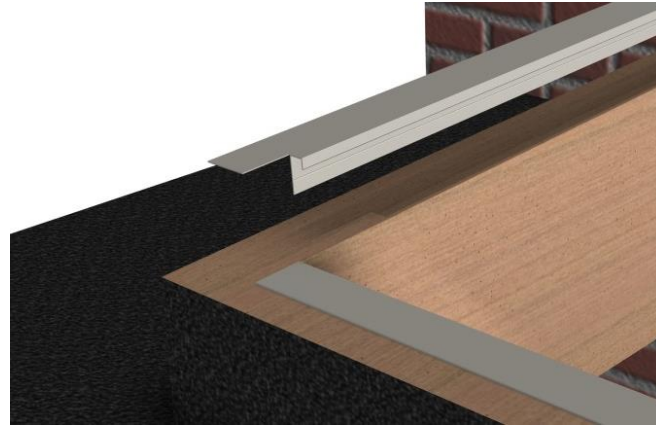

Figure 1 – Upstand top trim placement

The upstand top trim should be cut to size along its length to leave a dimension of 235 mm between the edge of the trim and outside of the upstand along the front edge, and 105 mm along the other three edges. These dimensions ensure that the visible internal upstand top is covered and that there is no contact between the upstand top trim and the exterior product framework. The upstand top trim is supplied with 5 grooves along the underside. These grooves can be used to help guide a saw or similar when trimming the cover to size. **Failure to follow this step exactly may result in a thermal bridge.**

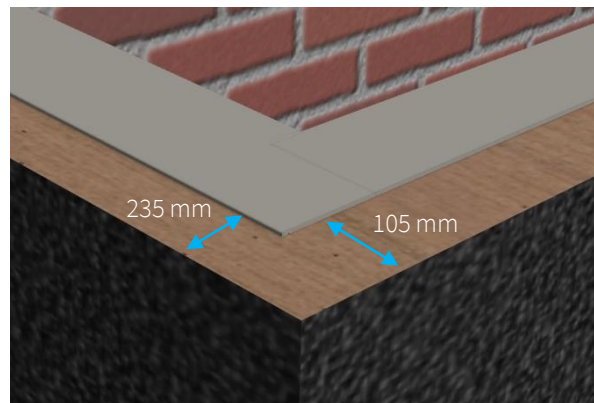

Figure 2 – Upstand top trim measurements

After all upstand top trim lengths have been cut to size and adjusted to fit, they can be fixed into place with the supplied fixings. Drill holes at approximately 500 mm centres using the groove to aid with positioning of the drill bit. The upstand top trim has been designed to accept standard 12 mm plasterboard to ensure a flush finish. Refer to the sales drawings for more information.

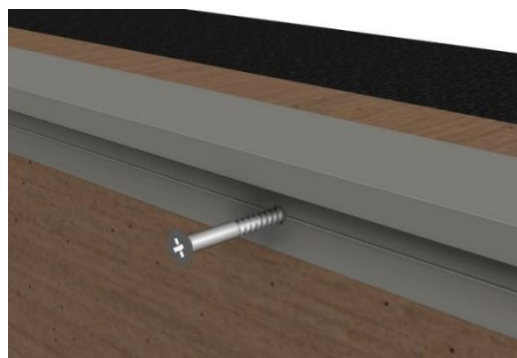

Figure 3 – Upstand top trim fixings

Fitting the Lifting Equipment



The lifting lugs are usually (but not always) attached to the product prior to dispatch. Once the product is installed, please return the lifting equipment to Glazing Vision.

To fit the lifting lugs, it may be necessary to peel back and remove some of the protective packaging. Leave as much as possible intact.

If required, remove the four cover caps concealing the lifting points.

Screw in the four lifting lug assemblies and ensure that they are secure and tightened to a torque of **300Nm**.

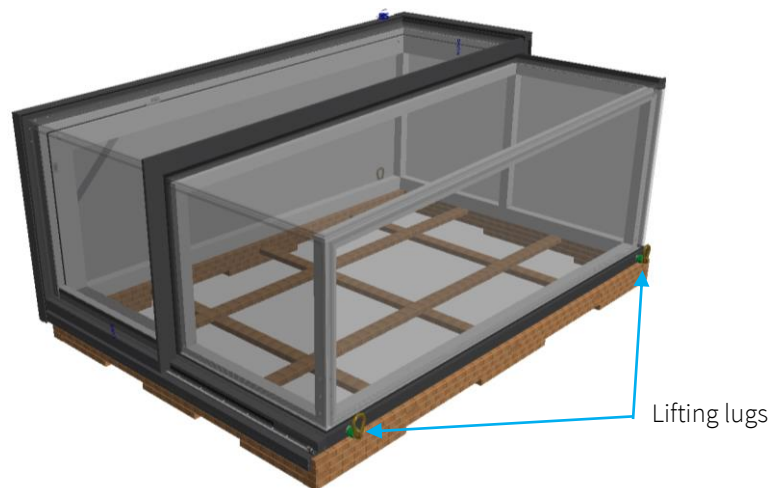

Figure 4 – Lifting lugs installed

Installation Procedure



Prior to commencing installation, **photographs of the fully weathered upstand and surrounding area** must be taken and retained for future reference.

Step 1

Remove all packaging from the product including polyfoam glass protection and low tack tape.



When removing the packaging, try to keep it intact as much as possible, so that after installation it can be re-used to protect the product until project completion and final handover.

Step 2

Apply two large lines of silicone (supplied in the installation kit) to the top of the upstand. Along the front edge of the upstand the two lines of silicone need to be approximately 175 mm and 225 mm in from the outside face of the upstand, and along the other three edges the two lines of silicone need to be approximately 45 mm in and 95 mm in from the outside face of the upstand.

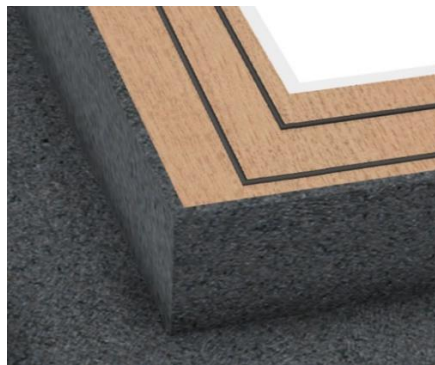

Figure 5 – Silicone placement

Step 3

Check that the lifting equipment is securely fitted to the unit.

Carefully lift the product to the installation site (roof) using strops underneath the wooden build frame (spreader bars will be needed – Glazing Vision recommends a 1 over 2 spreader arrangement but please consult with your lifting specialist). This is to ensure that the build frame does not separate from the product during the lift. **Do not lift the product to the roof using the lifting lugs** (these are for installation purposes only).

Step 4

When on the roof the product should be lifted off the wooden build frame (remove the fixings first) and placed onto the upstand. To do this, attach hooks to the shackle points on the lifting lugs (spreader bars will be needed) and then gently lower the product onto the upstand ensuring that the cables are not kinked or snagged under the framework – feed the cables exiting from the underside of the unit into the cable exit hole in the upstand.

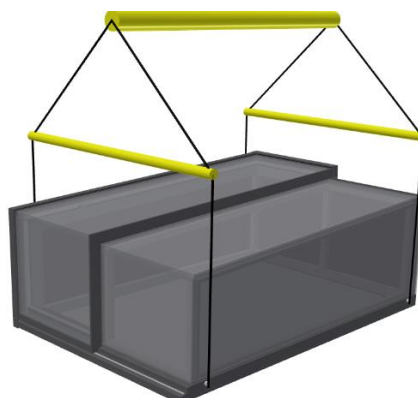

Figure 6 – Suggested lifting configuration

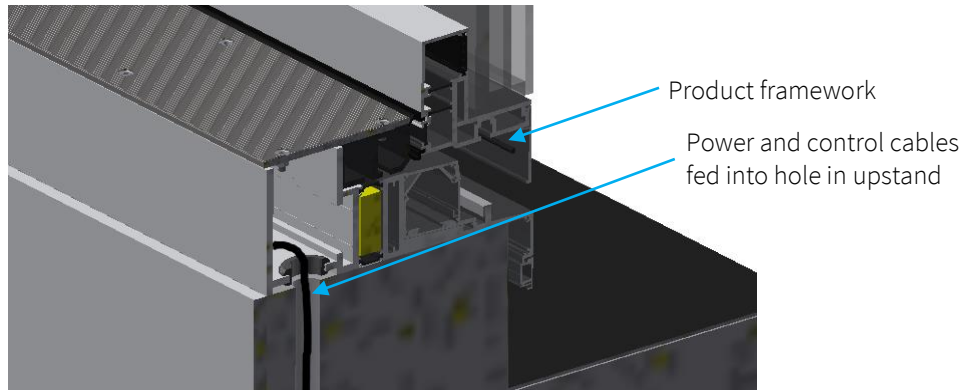

Figure 7 - Position of power and control cables in motor housing

With the framework in contact with the upstand top and the majority of the weight still supported by the crane/lifting equipment, adjust the position of the product on the upstand so that the internal framework is equally spaced and aligned with the internal finishes. Take care when positioning the product during final installation, as **once the weight of the unit has been placed onto the sealants it adheres to the upstand making repositioning difficult.**

Once satisfied that everything is correctly positioned, carefully release the weight of the product. Remove the crane and lifting lugs.



Once the product is installed, please return the lifting equipment to Glazing Vision.

Step 5

Gently prise all of the upstand fixing clip on covers off the framework drip legs.

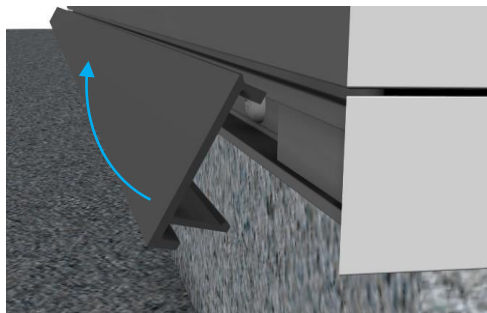

Figure 8 - Clip on cover

Drill Ø3 mm pilot holes into the upstand through the pre-drilled holes in the product's framework (concealed by the clip on cover). Secure the product to the upstand using the woodscrews and packers provided in the hardware kit. The packers must fill the entire gap between the upstand and product for each woodscrew. Care should be taken when tightening the fixings to ensure the frame does not distort. Fit the clip on covers and the four cover caps concealing the lifting points back onto the unit.



If installing into an alternative material to wood, it may be necessary to source suitable wall plugs and/or fixings to use instead of those provided.

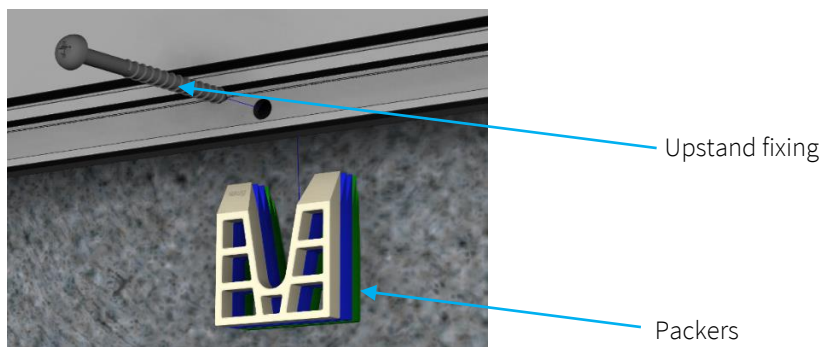

Figure 8 - Upstand fixings

Step 6

Once the product has been installed, the door position should be checked and if necessary realigned. This can be done by adding or removing shims on the wheel carriages at the top and bottom of the door. To do this, remove the external product flashings, then use an inflatable air wedge or similar to support the weight of the door. Next, working on one carriage at a time, loosen the fixings connecting the carriage to the door frame and add/remove shims as necessary. Once complete, re-tighten the carriage fixings. The door should be set up so that it runs parallel to the base frame with a good seal all around in the closed position. When the door is moved it should move freely and unimpeded. Once set up, the carriages should be locked in place by drilling and tapping two M6 x 6 mm holes into the product framework behind each carriage using the holes in the carriages as a template. **Take care not to damage the glass whilst doing this.** An M6 fixing with threadlock applied should then be inserted.

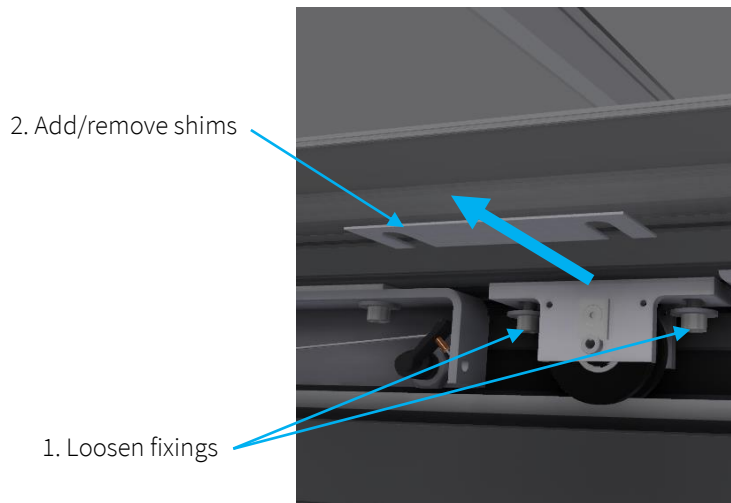

Figure 9 – Adjust door position

Step 7

Terminate the cables and apply power to the product following the wiring diagrams. Check that the power output from the PSU is between 24V and 26V when it reaches the product and adjust if necessary. Also install and connect any optional extras as directed (refer to Glazing Vision's sales drawings and wiring diagrams).

Step 8

Before initialising the Free Standing Skybox first check that there are no obstructions preventing the lid from moving freely e.g. scaffolding or loads placed on the lid. Check also that the product's mechanisms are properly engaged (i.e. the manual override procedure has not been carried out – refer to the operation and maintenance manual), failure to check this could result in mechanical damage. Switch on the power. If the product cannot be seen when standing next to the wall mounted control switch, ask for assistance before continuing. When you are ready to run the Free Standing Skybox for the first time, press the close button on the wall mounted control switch. This ensures that everything is zeroed prior to opening. The product can now be opened for the first time by pressing and holding the open button on the wall mounted control switch. When operating the product for the first time it is important to check that both mechanisms are working in tandem and the door moves evenly. If something does not function as expected, immediately let go of the switch and contact Glazing Vision for assistance.



Once installation has been completed take **photographs of the finished installation**. These must be retained for future reference.

Interior Finishing

Glazing Vision does not specify the finishes permitted except for the following stipulations:

- The finish must be built up to the internal dimension of the product – see Glazing Vision’s sales drawings.
- No interior metal component (for example edging strips for plastering) may touch any part of the product framework that is the outer colour (RAL 7015 grey as standard).
- Any airspaces between the aluminium frame of the product and the internal finishes must be filled with insulating material.
- Nothing should be fixed directly to the product.
- Nothing should interfere with any mechanisms or controls present or prevent the removal of the treadplate (access is required for maintenance reasons).



Contravention of any of these stipulations may severely undermine the thermal efficiency of the product.

Commissioning Checks

Check item	Tick box		
	PASS	FAIL	N/A
Visual checks with sliding frame closed:			
Has the installation been carried out as outlined in this document			
Has all transportation bolts/plates etc. been removed			
Carry out an internal and external check for any physical damage			
Ensure the perimeter of the sliding section is sealed all round			
DGU (glass) visual inspection approved			
PPC (paint) visual inspection approved			
Manual override engages/disengages easily:			
Dis-engage mechanisms using override handle ¹ and fully open Rooflight			
Close Rooflight and re-engage mechanism using override handle			
Operational check of open and close²:			
Control switch checked and tested ³			
Proximity sensor checked and tested; stops rooflight when obstructed			
Open position motor encoder count ⁴			
PSU Voltage Checked ⁵		Volts	
Run Current checked and adjusted as necessary		Amps	
Optional Extras checks			
Proximity sensor checked and tested; stops rooflight when obstructed			
Keypad checked and tested; Check Access Code ⁶			
Rain sensor checked and tested ⁷			
Key switch Internal/External checked and tested			
Check Fire activation from customer Fire System			
Thermostat checked and tested ⁸			
Remote Control checked and tested			
BMS checked and tested			
Battery Back Up operation checked and tested			
Client Handover			
Operation of product demonstrated to customer, including manual override and optional extras			
O&M Manual (plus optional extra details) handed to the customer			
Comments:			

Notes:

1. Ensure key is turned to dis-engage the solenoid bolt.
2. Using the Glazing Vision Config App, plug the tablet/Laptop RS485 dongle into the controller Loom and monitor a complete cycle, i.e. open the rooflight fully then close fully.
3. Check LED's and functional operation. Should illuminate Red, Green and Blue when powering up.
4. Use Config App, import settings and check Summary Tab for open position.
5. Adjust PSU to 26Volts if required. This should be set during production.
6. Refer to Keypad "Rooflight Security Instructions" printout.
7. Using a spray bottle filled with water, apply 2 full squirts of water spray from 300mm distance to the rain sensor head.
8. Check if setup correctly (If not set, see TWI-050 - Digital Thermostat E0533 v1.1).